



Price List For Moms & Dads

Contact us to book

☎ : 7337783316 📷 : lilclippersstreet



FACE SERVICES

Threading

Eyebrows	100
Upper-Lip	80
Forehead	80
Chin	80
Full Face	340

Facial

Clean-Up	529
Rejuvenating Fruit	799
Wine	1000
Gold	1150
Diamond	1250
Platinum Sheen	1450

Waxing

	<i>Normal</i>	<i>Ricca</i>
Eyebrows	150	200
Upper Lip	120	180
Forehead	120	180
Chin	120	180
Full Face	510	650

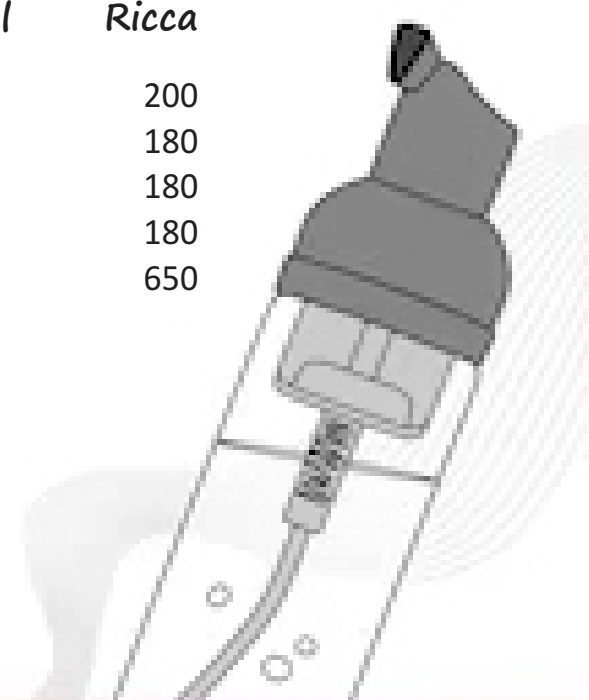
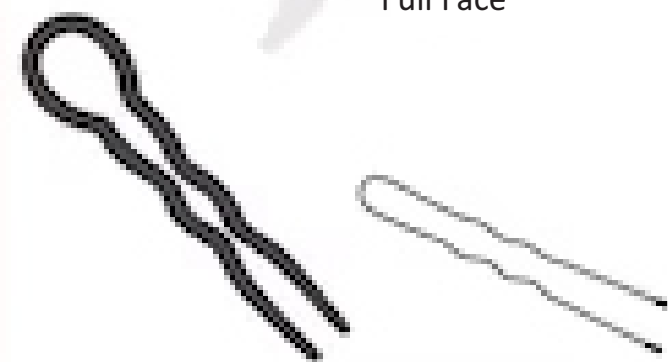
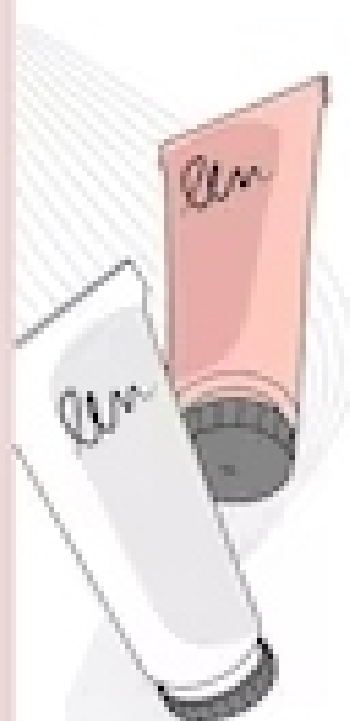
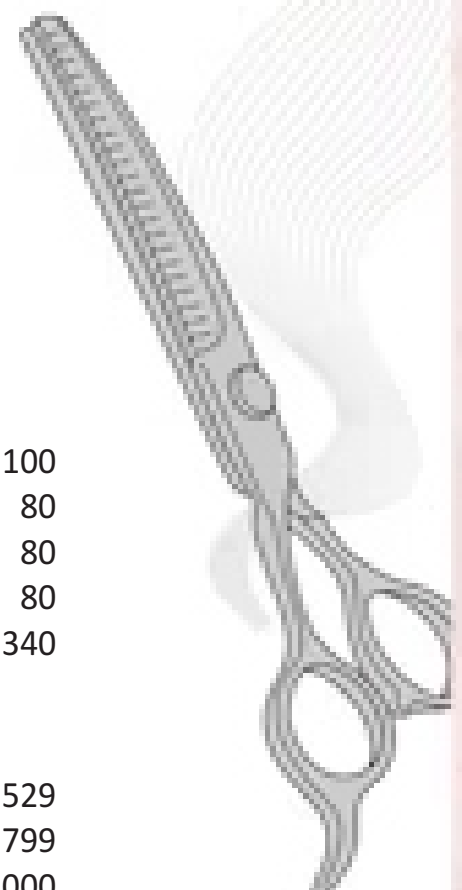



FACE / BODY SERVICES

De-Tan Treatment



Face	500
Hand	700
Half Legs	800
Feet	400
Underarms	200
Round Neck	600
Back Tan	800

Bleaching

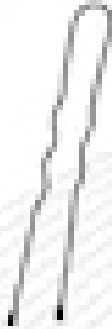

Face	399
Full Arms	1000
Full Legs	1200
Underarms	250
Round Neck	600
Full Body	1800

Quick Services

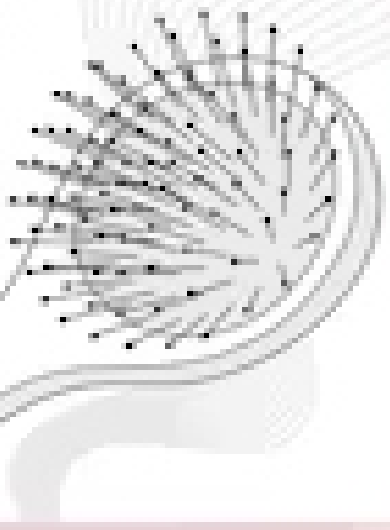
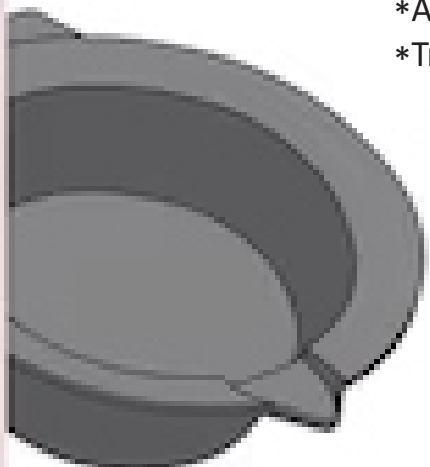

ALGAE PEEL-OFF FACIAL MASK	
*Activated Charcoal	849
*Tropical Vitamin-C	849



WAXING SERVICES

	<i>Normal</i>	<i>Ricca</i>
Full Arms	350	650
Half Arms	200	400
Underarms	120	190
Full Leg	599	999
Half Leg	299	499
Stomach	325	499
Back	425	540
Bikini Line	299	699
Bikini Wax	999	1499
Full Body	2000	2800



HAIR SERVICES

	<i>With Hair Wash</i>	<i>Without Hair Wash</i>
Moms Hair Cut	1199	899
Dads Hair Cut	349	249
Basic Trimming		399
Shape Trimming		549
Styling	949	599
Dads Beard Styling		149

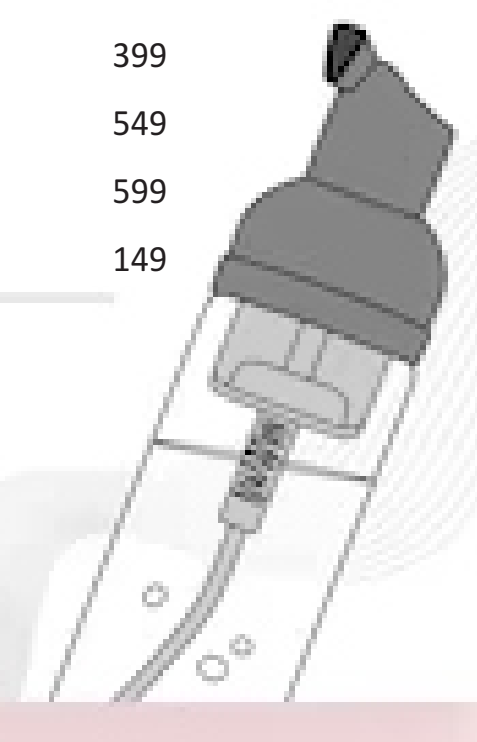



SPA SERVICES

Manicure

Normal / Basic	399
Bubblegum	849
Ice Cream	849
Wine	899
Fruit	699

Pedicure

Normal / Basic	599
Bubblegum	1199
Ice Cream	1199
Wine	999
Fruit	899

Oil Massage

Head	499
Full body	1599

Hair Spa

Loreal	1249
Matrix	1149